

# Other series

Nitrogen gas springs for dies / Cilindri all'azoto per stampi



## CF

Nitrogen gas springs with fixing flange, threaded on the cylinder body to ensure a higher safety level compared with flanges fixed with lock ring. With increased initial force, linkable to open system.

*Cilindri con flangia di fissaggio, filettata sul corpo per una maggiore sicurezza rispetto alle flange fissate con anelli metallici. Potenziati nelle forze, collegabili a sistema.*

CF

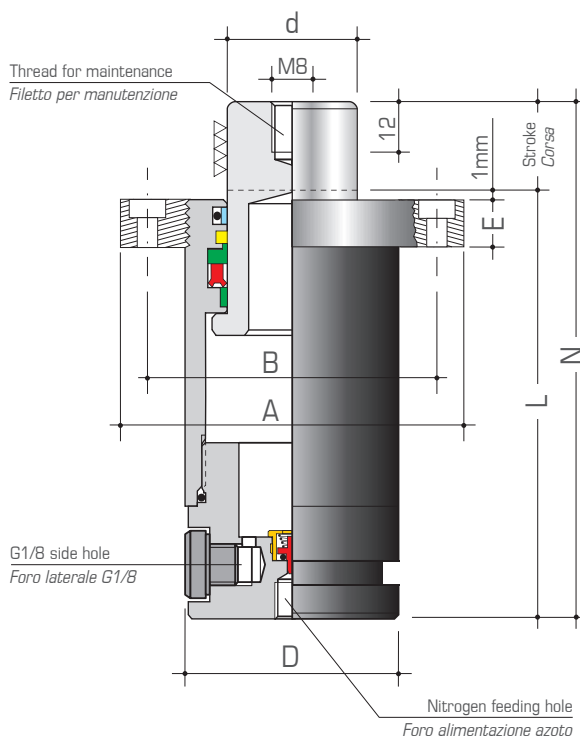

How to order

Esempio d'ordine

### 8 CF50-50 1500daN

No. 8 nitrogen gas springs CF  $\varnothing$  50 mm, stroke 50 mm, initial force 1500 daN (new model), with fixing flange.

**ATTENTION: specify the required force**

### 8 CF50-50 1500daN

N° 8 cilindri all'azoto CF  $\varnothing$  50 mm, corsa 50 mm, forza iniziale 1500 daN (nuovo modello), con flangia di fissaggio.

**ATTENZIONE: indicare la forza desiderata**

STANDARD VERSION

VERSIONE STANDARD

Ready with cap with groove and G1/8 side hole, linkable to open system, from  $\varnothing$  50 mm.



Pronta da  $\varnothing$  50 mm con tappo con scanalatura e con foro laterale G1/8 per collegamento a sistema.

**Important use instructions on pages 10 & 11**

**Importanti istruzioni d'uso alle pagine 10 e 11**

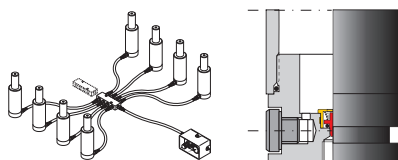
Standard version

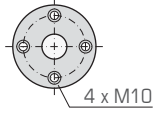
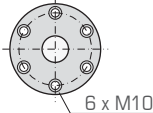
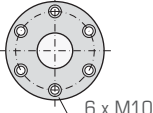
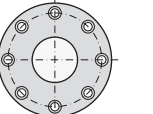

MODEL MODELLO	MAX STROKE mm CORSIA MAX mm	L mm	N mm	D mm	d mm	A mm	B mm	E mm				FLANGES FLANGE
									bar	daN	daN	
CF50-10	10	95	105	50	30	100	75	25	212	1500	2400	
25	25	110	135									
38	38	123	161									
50	50	135	185									
63	63	148	211									
80	80	165	245									
100	100	195	295									
125	125	220	345									
160	160	255	415									
200	200	295	495									
CF63-10	10	95	105	63	36	125	100	25	196	2000	3200	
25	25	110	135									
38	38	123	161									
50	50	135	185									
63	63	148	211									
80	80	165	245									
100	100	185	285									
125	125	220	345									
160	160	255	415									
200	200	295	495									
CF75-10	10	105	115	75	45	125	100	25	189	3000	4800	
25	25	120	145									
38	38	133	171									
50	50	145	195									
63	63	158	221									
80	80	175	255									
100	100	200	300									
125	125	225	350									
160	160	265	425									
200	200	310	510									
CF95-25	25	130	155	95	58	145	120	25	189	5000	8000	
38	38	143	181									
50	50	155	205									
63	63	168	231									
80	80	190	270									
100	100	210	310									
125	125	245	370									
160	160	280	440									
200	200	330	530									
CF120-25	25	140	165									
38	38	153	191									
50	50	165	215									
63	63	178	241									
80	80	195	275									
100	100	215	315									
125	125	250	375									
160	160	290	450									
200	200	340	540									

● Available on request / Disponibili a richiesta