



CRAL

Slow-return self-contained gas springs, with adjustable return speed.

Cilindri autonomi a ritorno rallentato, con velocità di ritorno regolabile.

PATENT PENDING

PATENT PENDING

CRAL

DIFFERENT CRAL TYPES / Working examples
DIVERSI TIPI DI CRAL / Esempi di funzionamento

— PRESS — CRAL
Adjustable range (indicative)

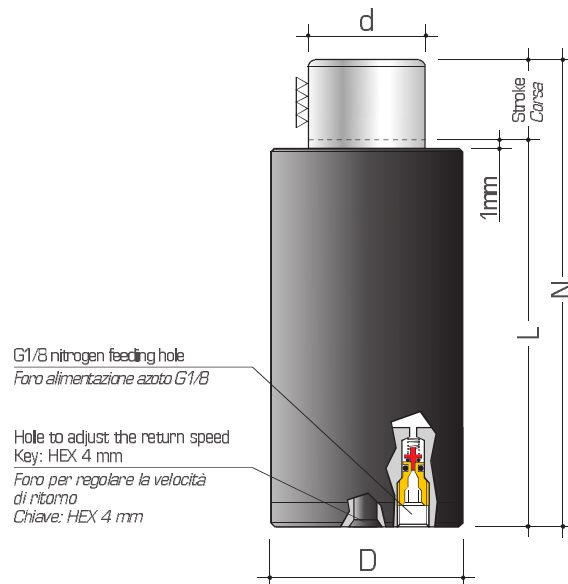
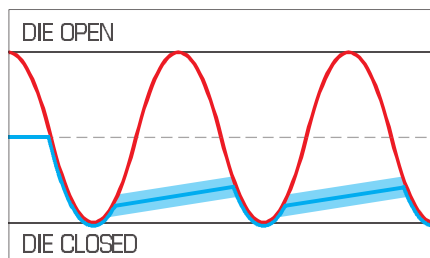
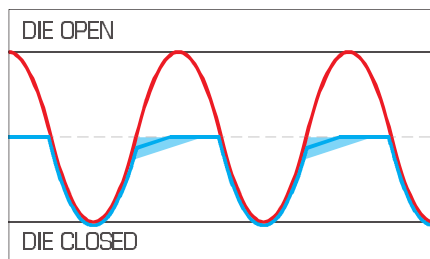
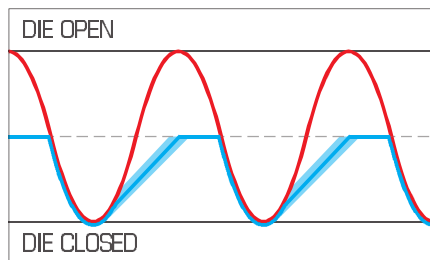

TECHNICAL NOTES

Important use instructions on pages 10 & 11

The slow-return stroke length can be adjusted with the screw at the gas spring bottom.

USE INSTRUCTIONS FOR CRAL GAS SPRINGS ARE PROVIDED WITH THE PRODUCT.

How to order

IMPORTANT: it is necessary to contact our technical department in order to make sure that CRAL gas springs can be used in the required application. Bordignon technical department will send you a dedicated form to be filled with the application data.

NOTE TECNICHE

Importanti istruzioni d'uso alle pagine 10-11



La lunghezza della corsa frenata sul ritorno è regolabile con la vite alla base del cilindro.

LE ISTRUZIONI D'USO PER I CILINDRI CRAL SONO FORNITE CON IL PRODOTTO.

Esempio d'ordine

IMPORTANTE: è necessario contattare il nostro ufficio tecnico per assicurarsi che i cilindri CRAL siano adatti per l'applicazione richiesta. Il reparto tecnico Bordignon vi invierà un apposito modulo da compilare con i dati dell'applicazione.

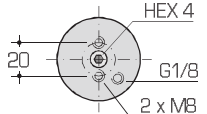
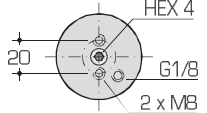
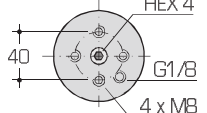
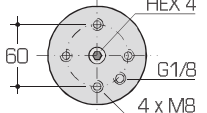
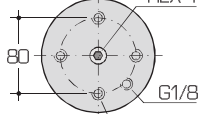

MODEL MODELLO	MAX STROKE mm CORSA MAX mm	L mm	N mm	D mm	d mm	 bar	 daN	 daN	GAS SPRING BASE BASE DEL CILINDRO
CRAL50-10	10	95	105	50	30	141	1000	1600	
25	25	110	135						
38	38	123	161						
50	50	135	185						
63	63	148	211						
80	80	165	245						
100	100	195	295						
CRAL63-10	10	95	105	63	36	147	1500	2400	
25	25	110	135						
38	38	123	161						
50	50	135	185						
63	63	148	211						
80	80	165	245						
100	100	185	285						
CRAL75-10	10	105	115	75	45	157	2500	4000	
25	25	120	145						
38	38	133	171						
50	50	145	195						
63	63	158	221						
80	80	175	255						
100	100	200	300						
CRAL95-25	25	130	155	95	58	151	4000	6400	
38	38	143	181						
50	50	155	205						
63	63	168	231						
80	80	190	270						
100	100	210	310						
CRAL120-25	25	140	165	120	75	147	6500	10400	
38	38	153	191						
50	50	165	215						
63	63	178	241						
80	80	195	275						
100	100	215	315						

● Available on request / Disponibili a richiesta