



## CSMF

Compact nitrogen gas springs with fixing flange, threaded on the cylinder body to ensure a higher safety level compared with flanges fixed with lock ring. With increased initial force.

*Cilindri compatti con flangia di fissaggio, filettata sul corpo per una maggiore sicurezza rispetto alle flange fissate con anelli metallici. Potenziati nelle forze.*

CSMF

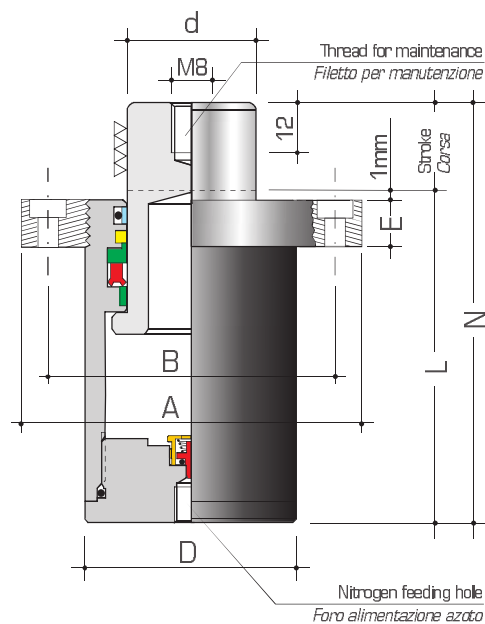

### How to order

#### 8 CSMF50-50 1500daN

No. 8 nitrogen gas springs CSMF  $\varnothing$  50 mm, stroke 50 mm, initial force 1500 daN (new model), with fixing flange.

**ATTENTION: specify the required force**

**Important use instructions  
on pages 10 & 11**

### Esempio d'ordine



#### 8 CSMF50-50 1500daN

N° 8 cilindri all'azoto CSMF  $\varnothing$  50 mm, corsa 50 mm, forza iniziale 1500 daN (nuovo modello), con flangia di fissaggio.

**ATTENZIONE: indicare la forza desiderata**

**Importanti istruzioni d'uso  
alle pagine 10 e 11**

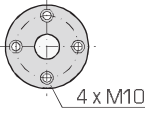
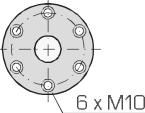
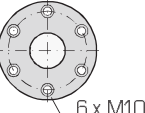
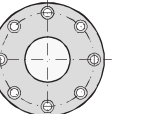

MODEL MODELLO	MAX STROKE mm CORSIA MAX mm	L mm	N mm	D mm	d mm	A mm	B mm	E mm	 bar	 daN	 daN	FLANGES FLANGE
CSMF50-10	10	60	70	50	30	100	75	25	212	1500	2400	
25	25	75	100									
38	38	88	126									
50	50	100	150									
63	63	113	176									
80	80	130	210									
100	100	150	250									
125	125	190	315									
160	160	235	395									
200	200	275	475									
CSMF63-10	10	65	75	63	36	125	100	25	196	2000	3200	
25	25	80	105									
38	38	93	131									
50	50	105	155									
63	63	118	181									
80	80	135	215									
100	100	160	260									
125	125	190	315									
160	160	235	395									
200	200	275	475									
CSMF75-10	10	65	75	75	45	125	100	25	189	3000	4800	
25	25	80	105									
38	38	93	131									
50	50	105	155									
63	63	118	181									
80	80	135	215									
100	100	155	255									
125	125	200	325									
160	160	250	410									
200	200	300	500									
CSMF95-25	25	90	115	95	58	145	120	25	189	5000	8000	
38	38	103	141									
50	50	115	165									
63	63	128	191									
80	80	155	235									
100	100	185	285									
125	125	220	345									
160	160	260	420									
200	200	310	510									
CSMF120-25	25	100	125									
38	38	113	151									
50	50	125	175									
63	63	138	201									
80	80	160	240									
100	100	190	290									
125	125	225	350									
160	160	270	430									
200	200	320	520									

• Available on request / Disponibili a richiesta